

LQH43CN100K03#

“#” indicates a package specification code.

Size Code 4532 (1812) in mm (in inch)



< List of part numbers with package codes >
LQH43CN100K03L

Appearance & Shape

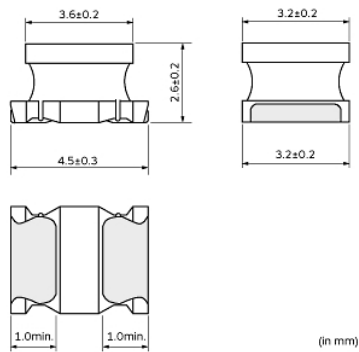
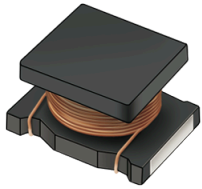

References

Packaging	Specifications	Standard Packing Quantity
L	180Embossed Tape	500
Mass (typ.)		
1 piece		0.13g

Notices

When rated current is applied to the products, self-temperature rise shall be limited to 20°C max and inductance will be within ±10% of initial inductance value.

Attention

- 1.This datasheet is downloaded from the website of Murata Manufacturing Co., Ltd. Therefore, it's specifications are subject to change or our products in it may be discontinued without advance notice. Please check with our sales representatives or product engineers before ordering.
- 2.This datasheet has only typical specifications because there is no space for detailed specifications. Therefore, please review our product specifications or consult the approval sheet for product specifications before ordering.

LQH43CN100K03#

“#” indicates a package specification code.



Specifications

L size	4.5±0.3mm
W size	3.2±0.2mm
T size	2.6±0.2mm
Size code inch (mm)	1812 (4532)
Inductance	10μH±10%
Inductance Test Frequency	1MHz
Rated current (Itemp) (Based on Temperature rise)	650mA
Max. of DC resistance	0.24Ω
Class of magnetic shield	No Shield
Self resonance frequency (min.)	23MHz
Operating Temperature Range(Self-temperature rise is not included)	-40°C to 85°C
Brand	Murata
Series	LQH43CN_03

Attention

1.This datasheet is downloaded from the website of Murata Manufacturing Co., Ltd. Therefore, it's specifications are subject to change or our products in it may be discontinued without advance notice. Please check with our sales representatives or product engineers before ordering.

2.This datasheet has only typical specifications because there is no space for detailed specifications.

Therefore, please review our product specifications or consult the approval sheet for product specifications before ordering.

LQH43CN100K03#

“#” indicates a package specification code.



Characteristic Data

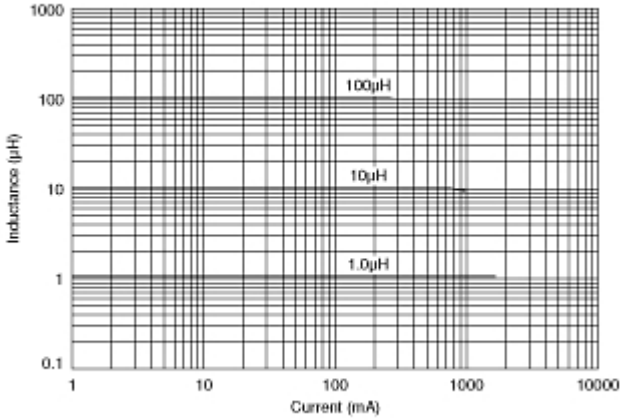

Impedance - Current Characteristics

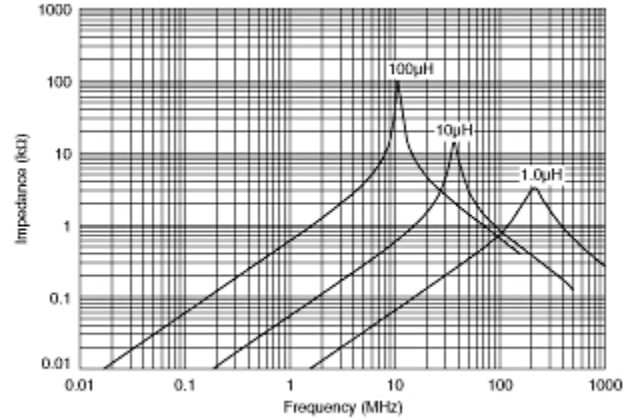

Impedance - Frequency Characteristics

Attention

- 1.This datasheet is downloaded from the website of Murata Manufacturing Co., Ltd. Therefore, it's specifications are subject to change or our products in it may be discontinued without advance notice. Please check with our sales representatives or product engineers before ordering.
- 2.This datasheet has only typical specifications because there is no space for detailed specifications. Therefore, please review our product specifications or consult the approval sheet for product specifications before ordering.